

## Cellink4G-Plus Quick Installation Instruction

1. Connect Antenna.
2. Connect T-Mobile/AT & T SIM card.
3. Connect Unit N.O to STRIKE on operator main board. Connect unit COM to GND on operator main board.
4. Connect Power adapter output 15VDC, 2A to the unit power input.

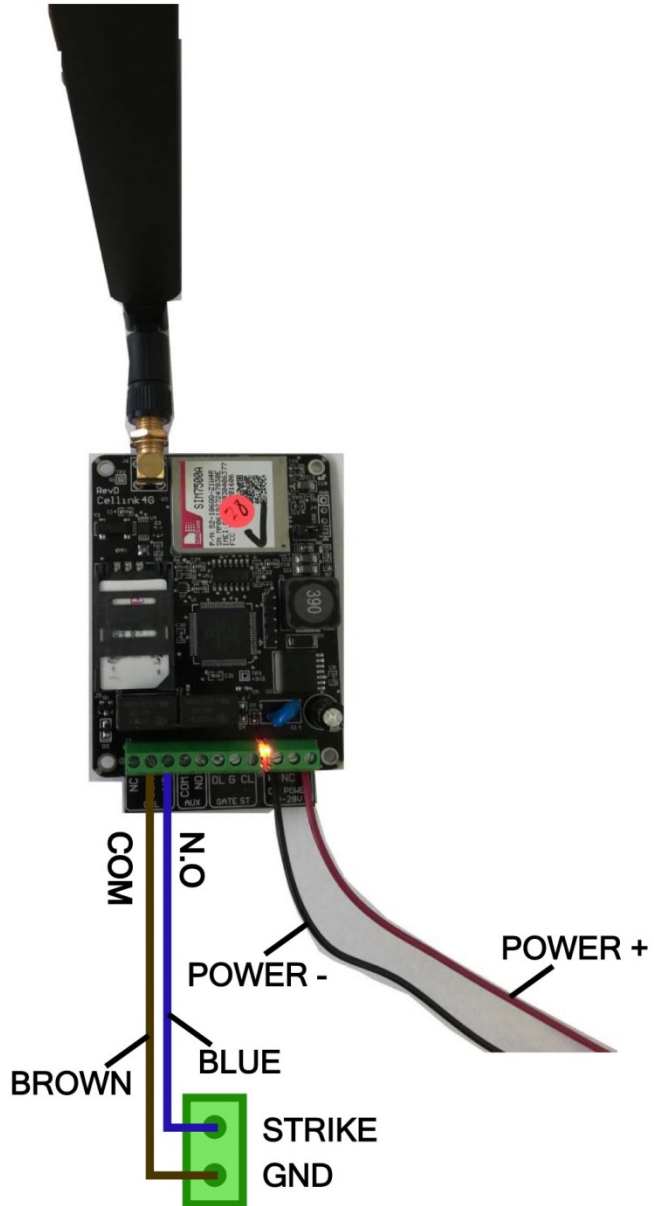

5. Power up the power adapter.
6. The orange color light will blink in about 6 seconds.



7. The blue color light will blink in about 1 minute.



8. Search and download smartphone APP "Platinum Access" from **Apple Store** for iPhone, or from **Amazon APP Store** for Android phones.
9. Follow instruction and install the Platinum Access APP in your smartphone.
10. Once you have installed the APP successfully, you will see the ACCESS icon on the phone screen.
11. Tap "ACCESS" icon to open the APP.

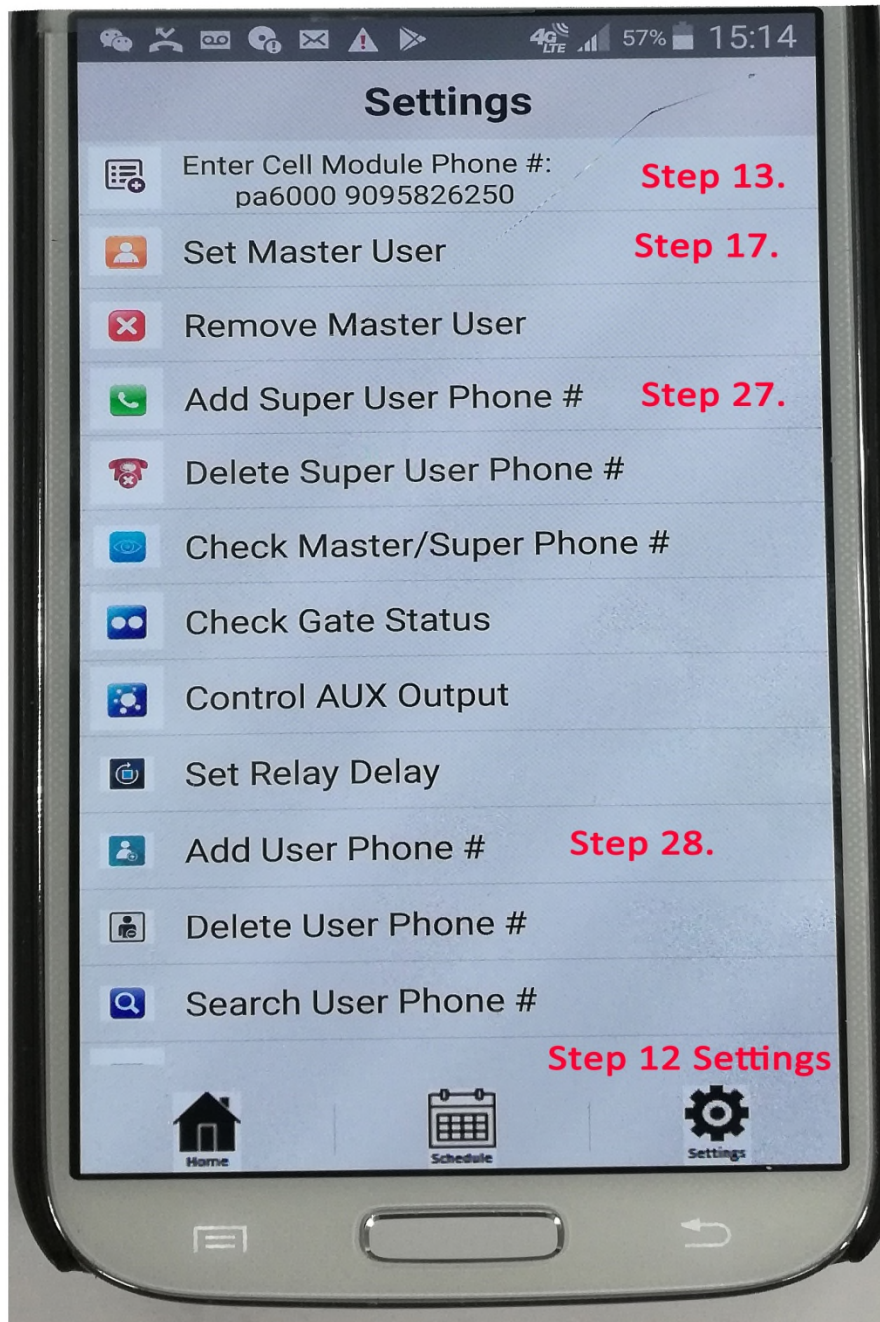

12. Tap SETTINGS at lower right hand corner to go to Settings page.
13. Tap “Enter Cell Module Phone#” go to Phone Entry Unit List page.
14. Tap “+” at the upper right hand corner to enter ID name & SIM card phone#.
15. Tap OK to go back to the Phone Entry Unit List page.
16. Tap “<” to go back to Settings page.
17. Tap “Set Master User” icon to set your phone to be the master unit.
18. Tap the SEND icon to send out the text command **“set master pn xxxxxxxxxx” (The SIM Card#)**.
19. If Cellink4G-Plus unit is working, you will receive “Done, thank you!” text message in about 5-10 seconds. If you have received the “Done, thank you!” text message. You can go to the step 20. Otherwise, you need to double check all wire connections to make sure all connections are good. And both Orange LED and blue LED are blinking.
20. Go to Settings page again.

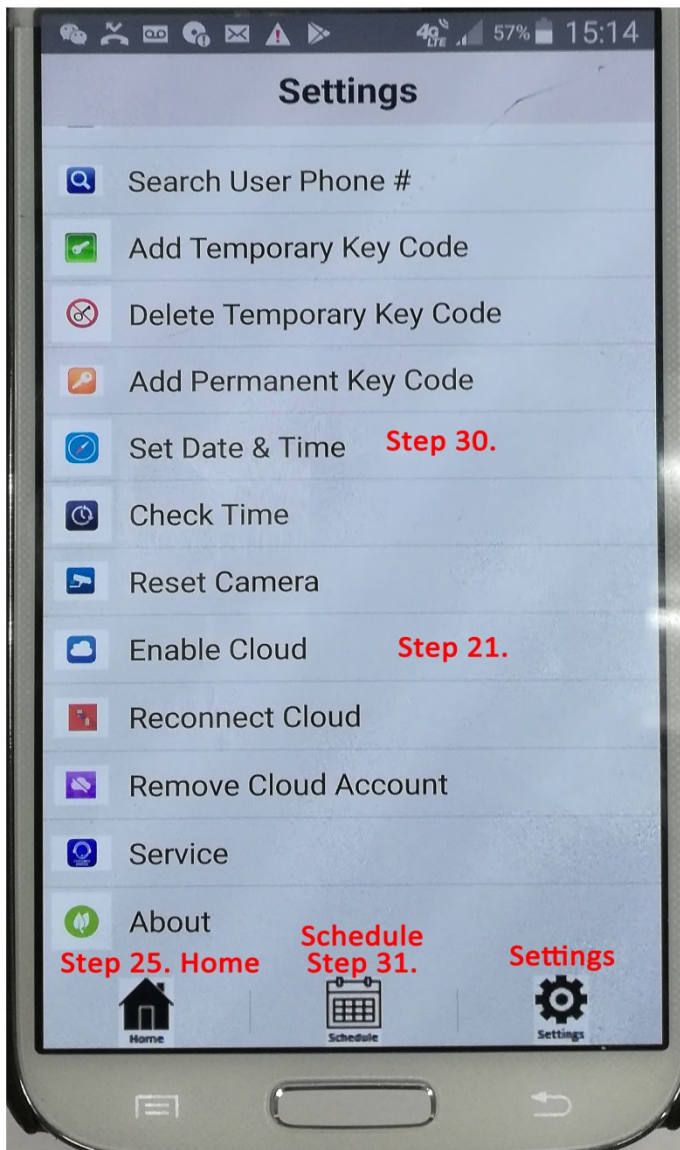

21. Tap 'Enable Cloud' icon.
22. Tap the SEND icon to send out the "en cloud xxxxxxxxx" text command(XXXXXXXXXX is the Cellink4G-Plus SIM Card phone number).



23. If Cellink4G-Plus unit working, you will receive "Done, thank you!" text message in about 5-10 seconds
24. Go to the APP Home page.
25. Tap "OPEN" icon.
26. If Cellink4G-Plus unit working, you will receive "Done, thank you!" text message in about 5-10 seconds
27. Next go to Settings page you can tap the "Add Super User Phone#" icon to add up to 8 super users.
28. You also can Tap "Add User Phone#" icon to add up to 2000 normal users.
29. Go to Setting page.
30. Tap "Set Date & Time" Icon to set the correct date and local current time.
31. You also can use the APP to set schedules at the Home page.
32. For the basic setup. You are done. If you want to use Platinum cloud to add users, setup schedules, and setup permission for users. Please visit Platinum website [www.platinumasi.com/phones](http://www.platinumasi.com/phones). And Tap "Platinum Cloud Link" Icon to register to setup your account. Please note that ONLY T-Mobile SIM Card can user the cloud service. AT & T server is not ready for the cloud service yet.

# Platinum Cloud Account Register procedure

On the login page, register an account with email address as user name. The registration is verified through email.

## Procedure 1. Amazon Web Service Email Verification

As per Amazon Web Service security policy, all emails that use to register to Platinum cloud account have to be verified and approved by Amazon Web Service. The email verification steps are as below:

- a. Call Platinum customer service and request a Platinum cloud account registration.
- b. Provide your email address for customer service to add in the user list.
- c. Once Platinum processes your request, an email will be sent to your email address from “**Amazon Web Service**” for email verification.
- d. Open the email and click the link in the text to complete the process. A verification successful message will be shown on the web page from the link.

## Procedure 2. Platinum Cloud Account Registration

Once the email address is verified by AWS, the Platinum cloud account can be registered by the steps below:

- a. Open the cloud web page from “<http://54.241.70.60/login.php>”.

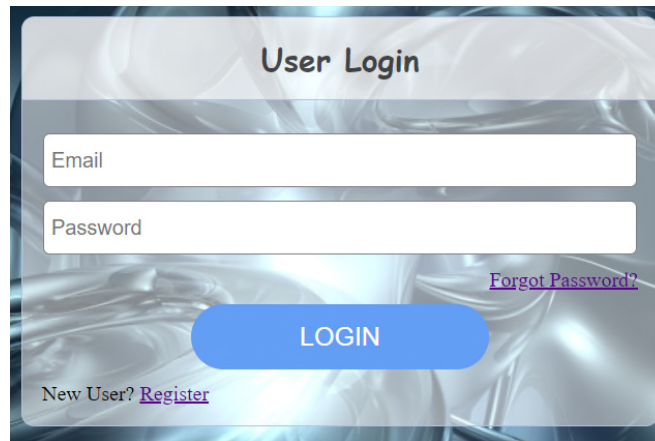

- b. Click “**Register**” to open the register page. Enter the AWS verified email address and set the password (**Password needs to be at least one number, one uppercase letter, one lowercase letter and at least 8 or more characters**).

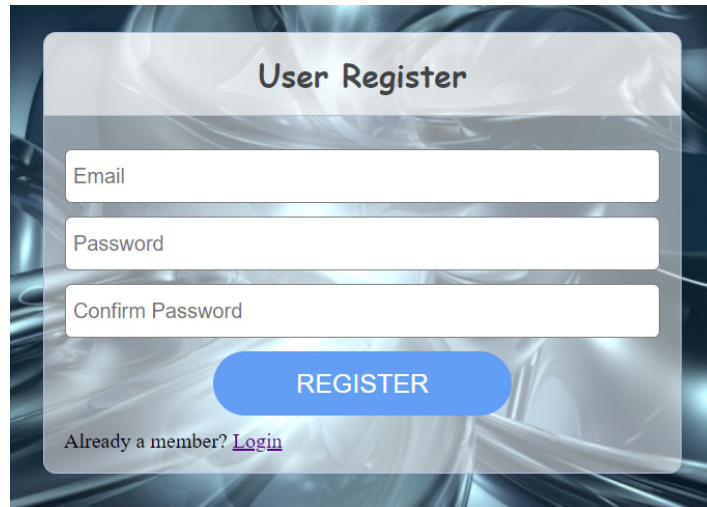

The image shows a 'User Register' form with a blue background. It features three input fields: 'Email', 'Password', and 'Confirm Password'. Below these fields is a blue 'REGISTER' button. At the bottom left, there is a link that says 'Already a member? [Login](#)'.

- c. Click the “**REGISTER**” button as shown at above picture, an email will be sent to the email address from “**Platinum Access Cloud**”.
- d. Open the email and click the link to complete the register process.
- e. Log in the cloud with the email and password.

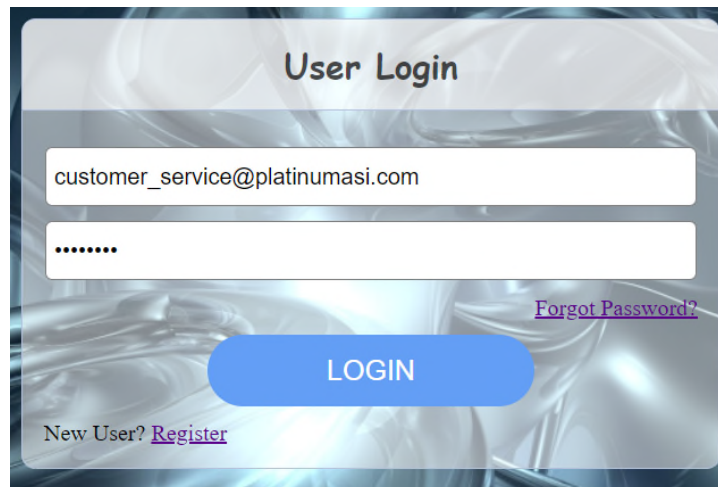

The image shows a 'User Login' form with a blue background. It features two input fields: the first contains the email 'customer\_service@platinumasi.com' and the second contains a masked password '.....'. To the right of the password field is a link that says '[Forgot Password?](#)'. Below the fields is a blue 'LOGIN' button. At the bottom left, there is a link that says 'New User? [Register](#)'.

- f. If the password is forgotten, click “Forgot Password ?” to reset the password.

# Cellink4G-Plus Wiring Diagram

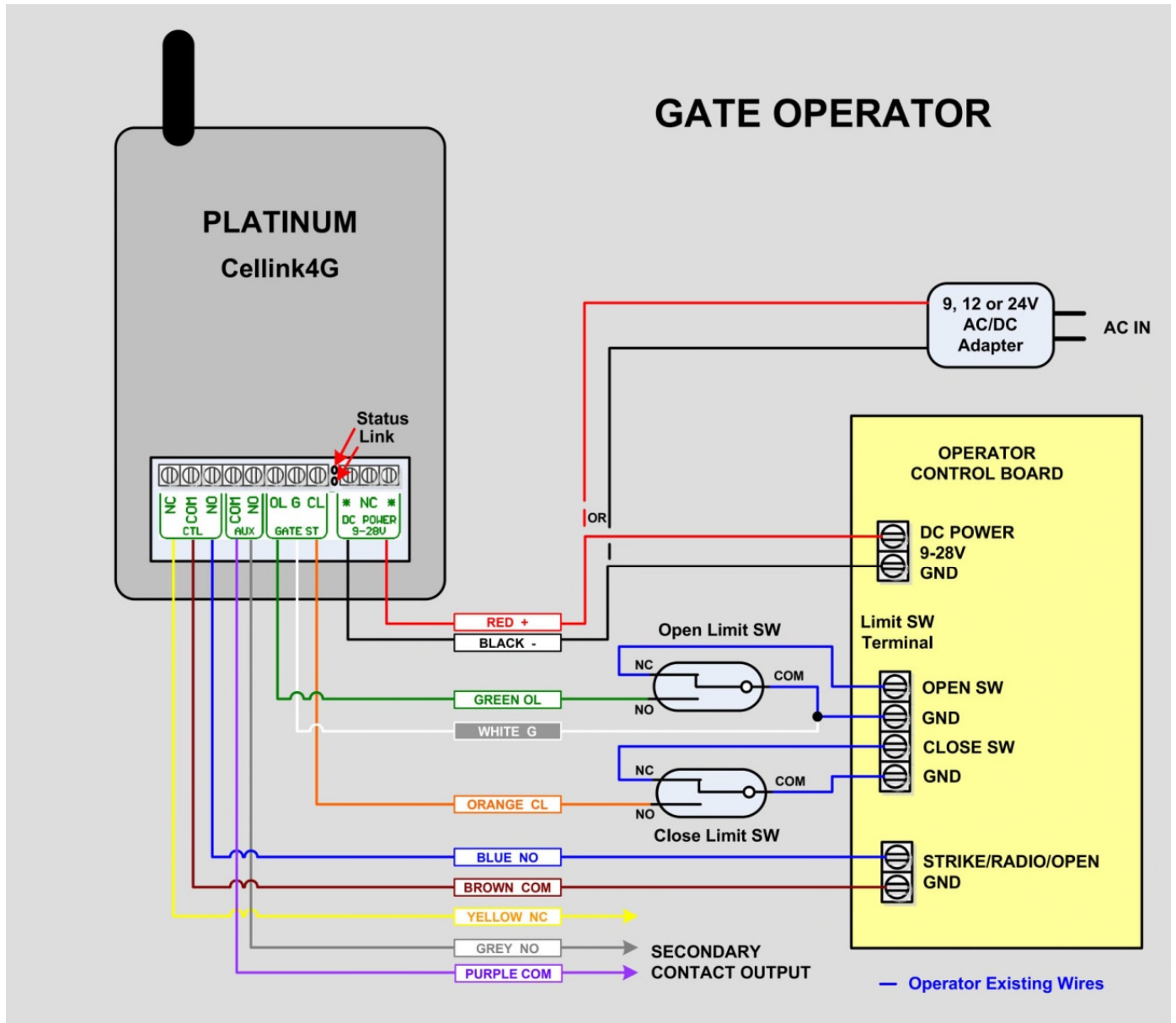

**Fig. 4 Wiring Diagram**